

LINSEIS

THERMAL ANALYSIS

**THERMO-
GRAVIMETRIC
ANALYZER**

TGA 1600



Since 1957 LINSEIS Corporation has been delivering outstanding service, know how and leading innovative products in the field of thermal analysis and thermo physical properties.

We are driven by innovation and customer satisfaction.

Customer satisfaction, innovation, flexibility and high quality are what LINSEIS represents. Thanks to these fundamentals our company enjoys an exceptional reputation among the leading scientific and industrial organizations. LINSEIS has been offering highly innovative benchmark products for many years.

The LINSEIS business unit of thermal analysis is involved in the complete range of thermo analytical equipment for R&D as well as quality control. We support applications in sectors such as polymers, chemical industry, inorganic building materials and environmental analytics. In addition, thermo physical properties of solids, liquids and melts can be analyzed.

LINSEIS provides technological leadership. We develop and manufacture thermo analytic and thermo physical testing equipment to the highest standards and precision. Due to our innovative drive and precision, we are a leading manufacturer of thermal Analysis equipment.

The development of thermo analytical testing machines requires significant research and a high degree of precision. LINSEIS Corp. invests in this research to the benefit of our customers.



Claus Linseis
Managing Director

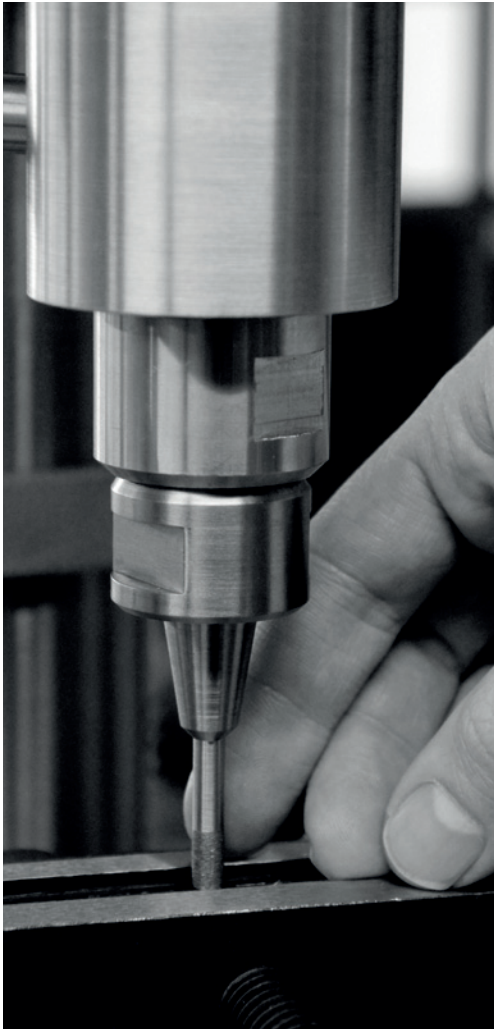

German engineering

The strive for the best due diligence and accountability is part of our DNA. Our history is affected by German engineering and strict quality control.

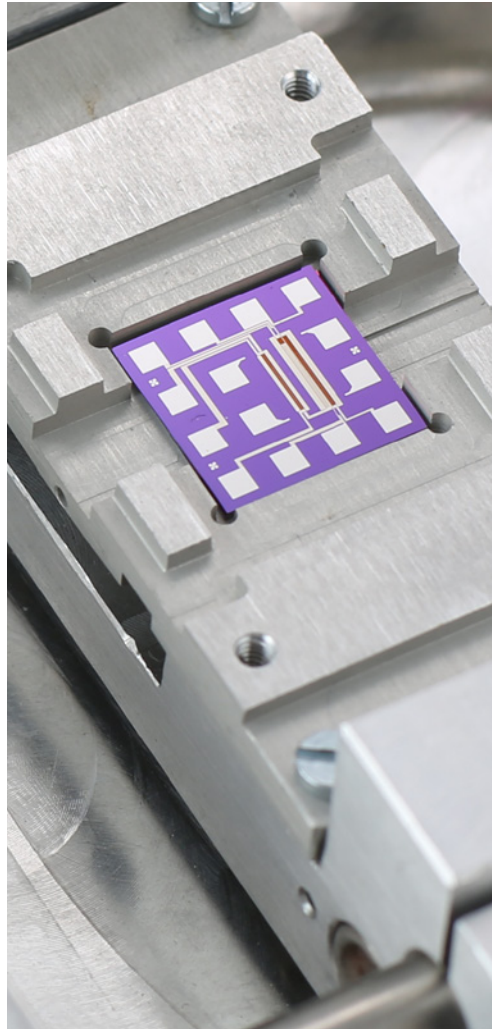

Innovation

We want to deliver the latest and best technology for our customers. LINSEIS continues to innovate and enhance our existing thermal analyzers. Our goal is constantly develop new technologies to enable continued discovery in Science.

SIMULTANEOUS THERMAL ANALYSIS

Simultaneous TGA-DTA/DSC measures both, heat flow and weight change of a sample as a function of temperature or time under controlled atmosphere. Simultaneous measurement of these two material properties not only improves productivity but also simplifies interpretation

of the results. The complimentary information obtained allows differentiation between endothermic and exothermic events which have no associated weight change (e.g., melting and crystallization) and those which involve a weight change (e.g., degradation).

High precision beam balance

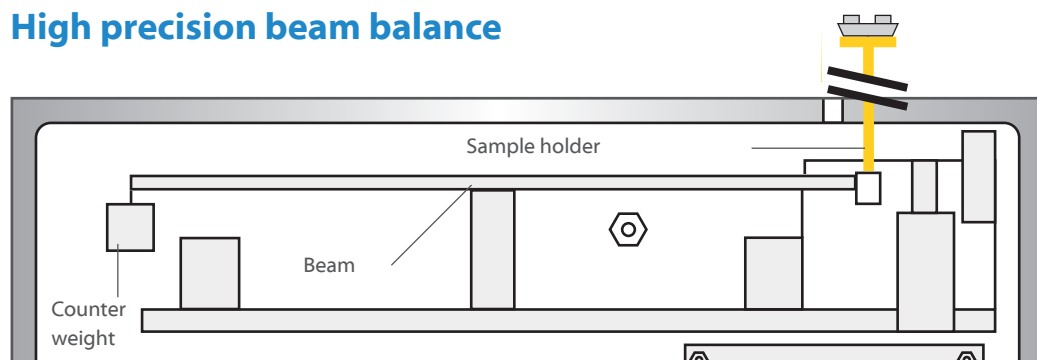

Our different microbalances are specifically designed to accomplish thermal analysis tasks in the best possible way.

Providing ultra light weight design to follow fast weight changes and symmetric construction for ultra low drift long term measurements.

Advantages of LINSEIS Balance Design

- not affected by local gravity
- not affected by thermal fluctuations
- highest possible PRECISION
- direct measurement of mass
- depending on model, balance can handle mg up to 50g sample mass

Advantages of combined TG+DSC

- same geometry
- stoichiometry
- same temperature profile
- same atmosphere
- same humidity

DSC- True Heat Flow measurement

Quantitative DSC-signal

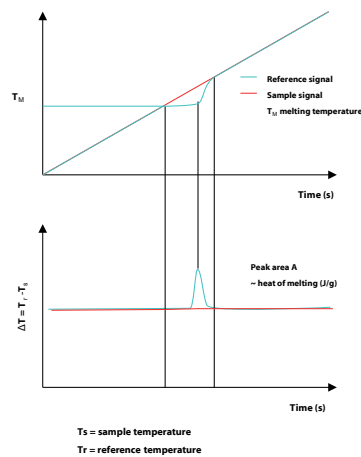
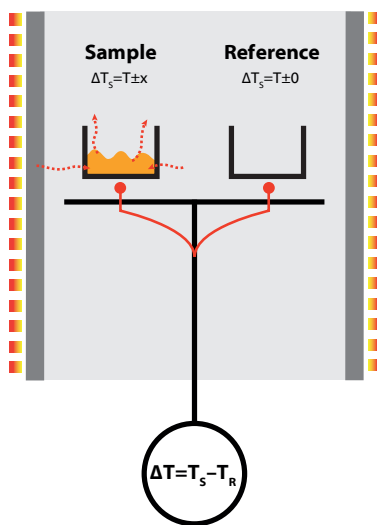

Differential Scanning Calorimetry (DSC)

"A technique in which the difference in energy input into a substance and a reference material is measured as a function of temperature, while the substance and reference material are subjected to a controlled temperature program."

Differential Signal

The differential signal is displayed as a baseline. Effects, for example the melting of a metal, can be observed as a peak. The area of the peak gives the amount of enthalpy and the direction of the peak indicates the way of heat flux – endothermic (down) or exothermic (up).

Temperature vs. Time

During an effect like a reaction, decomposition or phase transition, a temperature difference (heat flux difference) between the sample and the reference crucible can be measured by means of a thermocouple.

MEASURABLE PROPERTIES

- Mass change as % and mg
- Rate controlled mass loss
- Evaluation of mass loss
- Residue mass evaluation
- Compositional analysis

- Enthalpy
- Endo- / Exo- thermic
- Phase transformation
- Melting point
- Glass point
- Crystallinity

- Thermal stability
- Oxidation stability
- Purity
- Solidus / Liquidus relationship
- Product identification

SENSORS

Our TGA can be equipped with an unmatched amount of different user exchangeable TG-DSC, TG-DTA or TG sensors.

Each sensor is available with different thermocouples to provide the highest sensitivity for your desired temperature range.

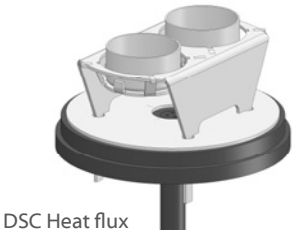

DSC Heat flux

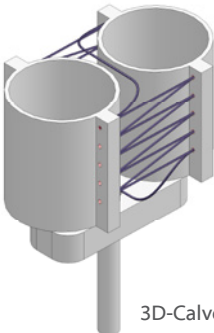

3D-Calvet-DSC sensor

TG-DSC

- Al₂O₃
- Platinum
- Aluminium
- others



0.12ml





0.12ml



custom volume



Different crucibles available / broad variety

●
●
●
●
●
●
●
●
●



DTA-sensor

-
-
-



Cap



0.3ml or custom volume



Crucible

-
-
-

TG-DTA

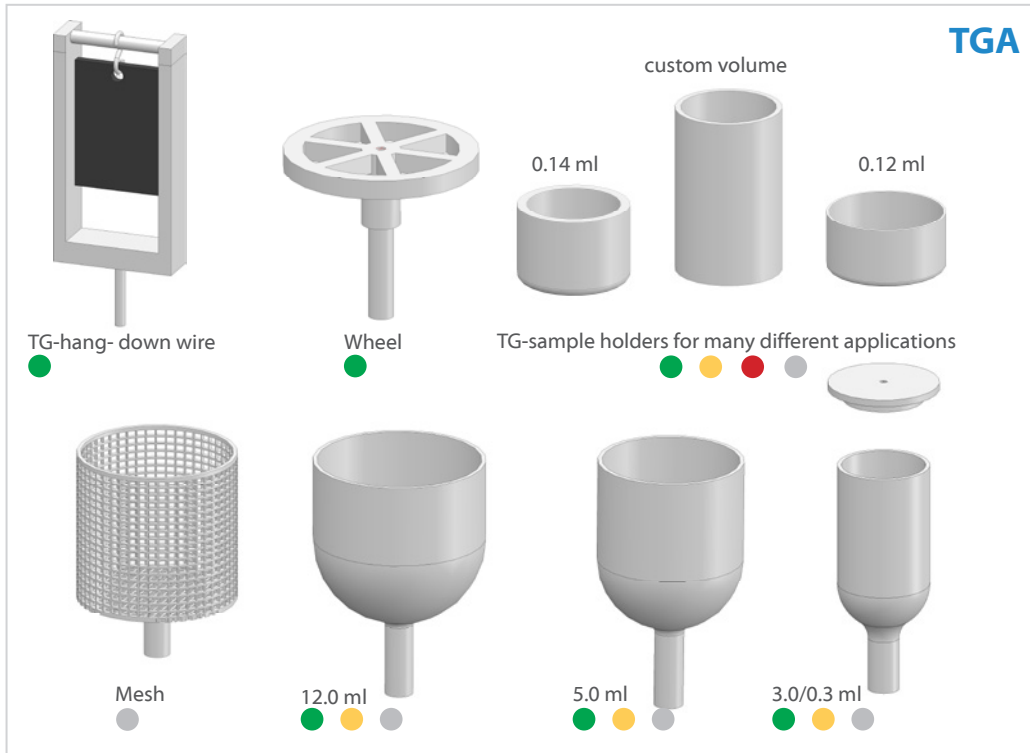

Best possible sensitivity for your application

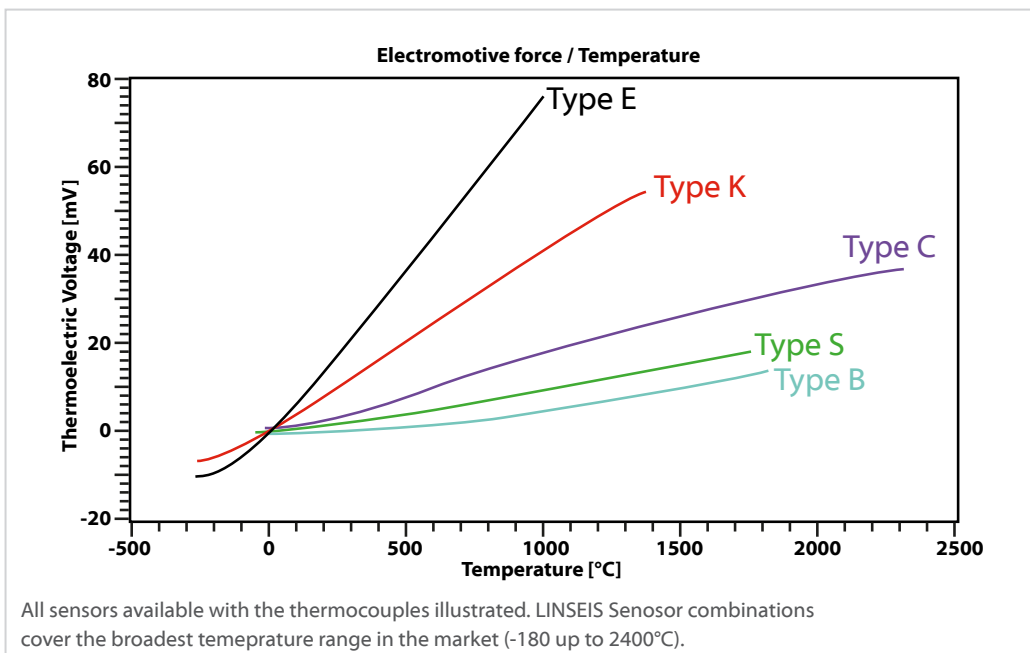

UNIQUE FEATURES

Vacuum and controlled atmosphere

The balance design provide for high vacuum, inert, reducing, oxidizing or humidified atmosphere. Furthermore, the instrument can be pressurized up to 5 bar overpressure (option). Certain corrosive conditions can be analyzed with proper precautions. The system is capable of adapting residual gas analysis systems using an optional heated capillary.

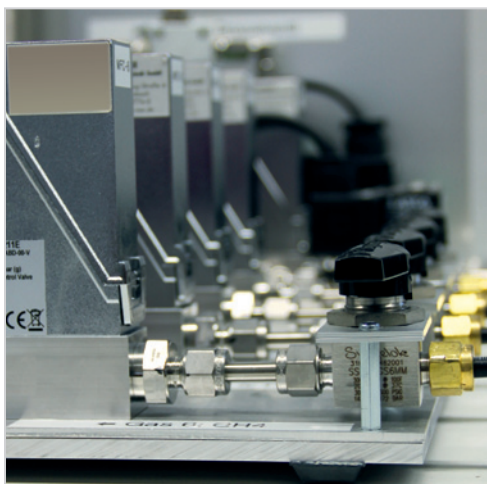

Evolved gas analysis

Optional gas analysis with MS, FTIR or GCMS is possible. This provides valuable additional information.

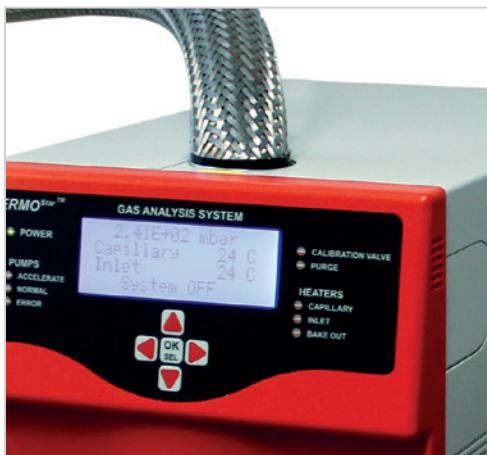

Sample robot

Our TGA PT 1000 and 1600 can be equipped with a proven sample robot for unattended sample measurements.

Wide temperature range -150 to 2400°C

The LINSEIS STA instruments can be equipped with up to three furnaces at the same time. A broad variety of different furnaces is available to enable measurements in the widest temperature range on the market. Unmatched selection of furnaces for widest possible temperature range.





Starter kit

The starter kit includes a variety of tool such as scissors, cutting tools, anti electrostatic tweezers, magnifier, crucible holder, pipette, rasps, spatula etc.

Oxygen Getter Material OGM

The LINSEIS oxygen getter system (OGM) can be placed in any LINSEIS system as a modification

of the sample gas capillary. It is used to getter smallest traces of residual oxygen in the sample chamber by offering a stronger oxygen affinity than sample materials, combined with a high effective surface to ensure the oxygen molecules react with the getter before they have a chance to get in touch with the sample. Especially for oxidation sensitive samples, where hydrogen gas mixtures can't be used or very small enthalpy signals are expected, the OGM is a very effective and easy to use solution. With its modular character, it can be used for special experiments and can be easily removed for measurements under air or where the oxygen content is less important.

Furnace Programm

Temperature	Type	Element	Atmosphere	TC-Type
-150 -- -500°C	L81/264	Kanthal	inert, oxid., red., vac.	K
-150 – 1000°C	L81/264ER	Kanthal	inert, oxid., red., vac.	K
RT – 1000°C	L81/220	Kanthal	inert, oxid., red., vac.	K
RT – 1200°C	L81/IR	IR Heater	inert, oxid., red., vac.	S
RT – 1500°C	L81/230Pt	Precious Metal	inert, oxid., red., vac.	S
RT – 1600°C	L81/240	SiC	inert, oxid., red., vac.	S
RT – 1650°C	L81/240Rh	Precious Metal	inert, oxid., red., vac.	B
RT – 1750°C	L81/250	MoSi ₂	inert, oxid., red., vac.	B
RT – 2000°C	L81/260	Graphite	inert., red., (oxid. up to 1750°C)	C
RT – 2400°C	L81/260	Graphite	inert., red., (oxid. up to 1750°C)	C
Special Furnaces				
RT – 1600/1750°C	L81/240/250 WV	SiC/MoSi ₂	water vapor furnace	
RT – 1100/1600°C	L81/IR/HF	IR/HF	high speed furnaces up to 100°C/s	

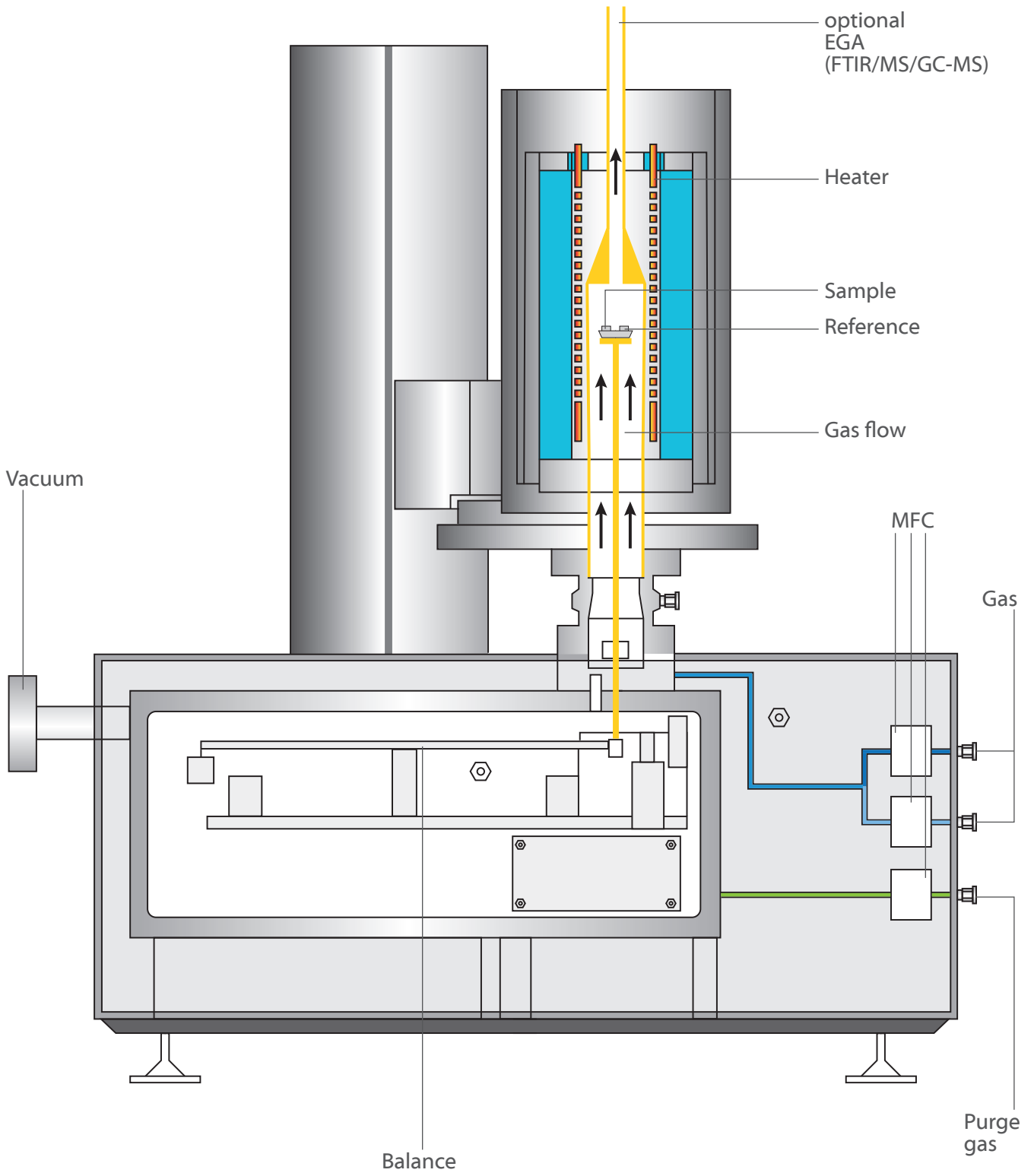

Benefits of the vertical top loading design

The vertical “sample on top” design of the LINSEIS thermobalance provides highest possible accuracy due to a stable position of the sample and easy sample handling.

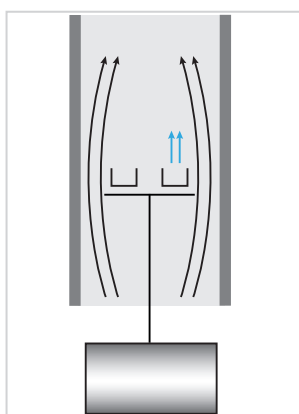

Vertical system (sample on top)

LINSEIS configuration

Advantages:

- Easy sample handling
- Easy exchange of sample holder
- Stable position of the sample in the furnace (critical for good DTA/DSC and Cp results)

Disadvantage:

- Complicated construction

Horizontal system

Advantages:

- Small buoyancy effects

Disadvantages:

- Sensor exchange very difficult
- Sample handling difficult
- Very high purge gas rate required
- Problems due to sensor expansion during heating/cooling

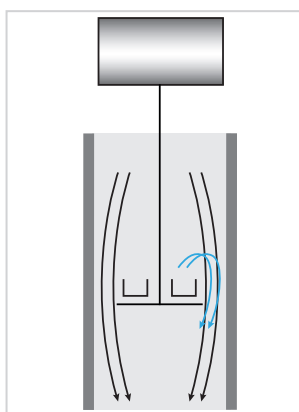
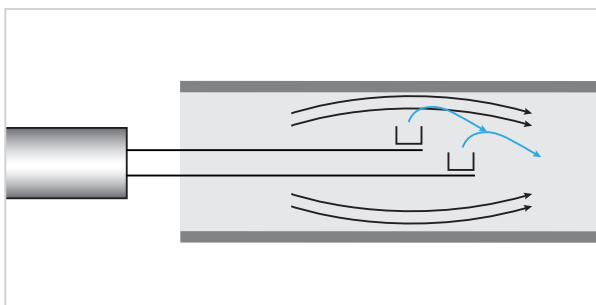

Vertical system (sample on bottom)

Advantage:

- Stable position within furnace

Disadvantages:

- Difficult sensor exchange
- “Dangerous” gas flow within balance housing (sample gets blown out)
- Sensor position depends on sample weight

TGA PT 1600

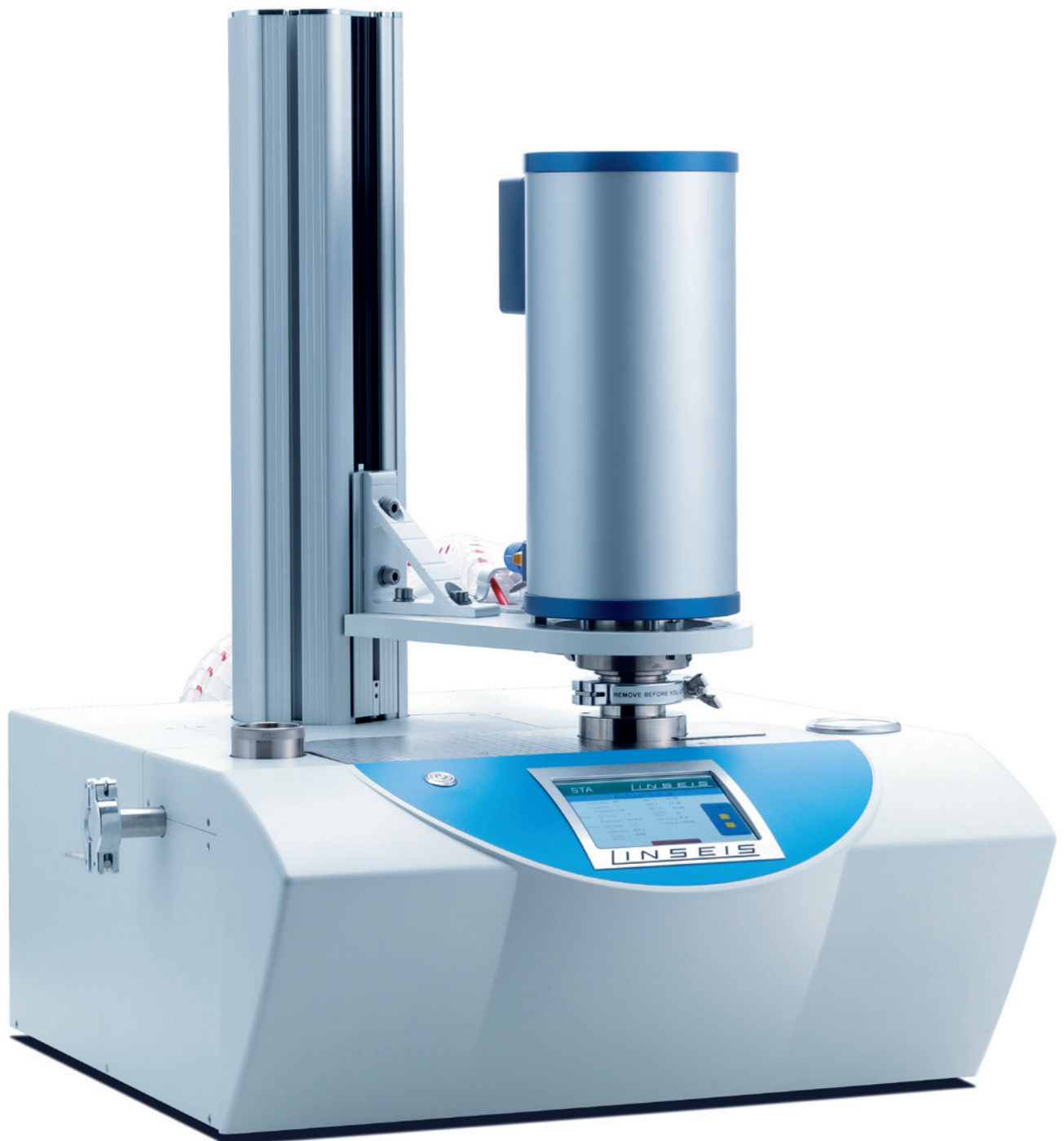

TGA PT 1600/1

The highest resolution 0.025 µg balance for small sample quantities allows the detection of very small effects with highest accuracy.

TGA PT 1600/2

The standard model covers a broad application range with excellent resolution 0.1 µg and accuracy.

TGA PT 1600/3

The high mass variant allows measuring samples with big volumes or weight 35/50g to determine even small effects within a big amount of inhomogeneous material.

TG - DSC/DTA + Pressure

SOFTWARE

All LINSEIS thermo analytical instruments are PC controlled. The individual software modules run exclusively under Microsoft® Windows® operating systems. The complete software consists of 3 modules: temperature control, data acquisition and data evaluation. The Windows® software incorporates all essential features for measurement preparation, execution, and evaluation of a thermoanalytical measurement. Thanks to our specialists and application experts, LINSEIS was able to develop comprehensive easy to understand user friendly application driven software.

Features-Software:

- Program capable of text editing
- Data security in case of power failure
- Thermocouple break protection
- Repetition measurements with minimum parameter input
- Evaluation of current measurement
- Curve comparison up to 32 curves
- Storage and export of evaluations
- Export and import of data ASCII
- Data export to MS Excel
- Multi-methods analysis (DSC TG, TMA, DIL, etc.)
- Zoom function
- 1 and 2 derivation
- Programmable gas control
- Curve arithmetics
- Statistical evaluation package
- Free scaling

- Optional Kinetic and Lifetime Prediction Software packages

TG – Features:

- Mass change as % and mg
- Rate Controlled Mass Loss (RCML)
- Evaluation of mass loss
- Residue mass evaluation

HDSC – Features:

- Glass transition temperature
- Complex peak evaluation
- Multipoint calibration for sample temperature
- Multipoint calibration for change of enthalpy
- Cp calibration for heat flow
- Signal-steered measuring procedures

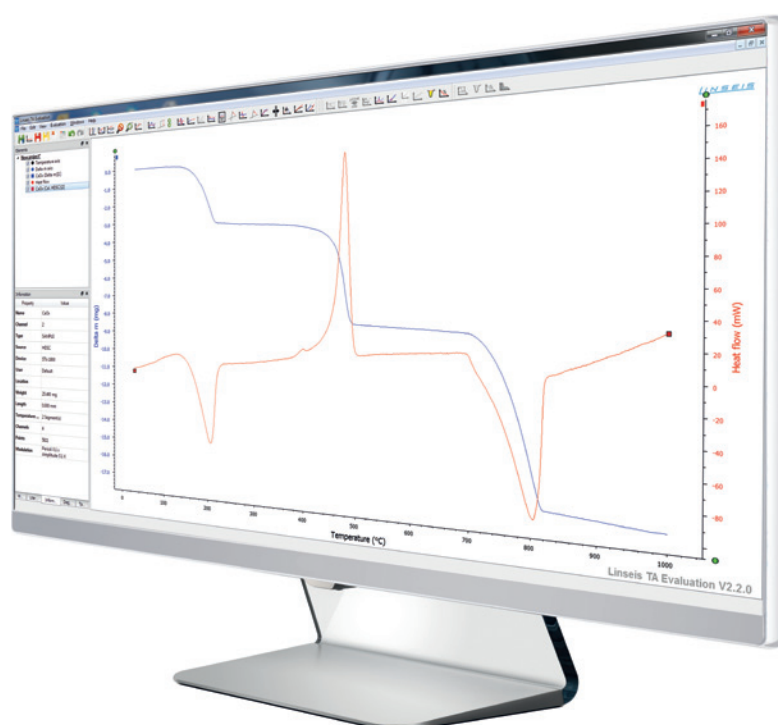

Thermal Library

The LINSEIS Thermal Library software package comes as an option for the well-known, user friendly LINSEIS Platinum evaluation software that is integrated in almost all our instruments.

The Thermal Library allows you the comparison of the complete curves with a data base providing thousands of references and standard materials within only 1-2 seconds.

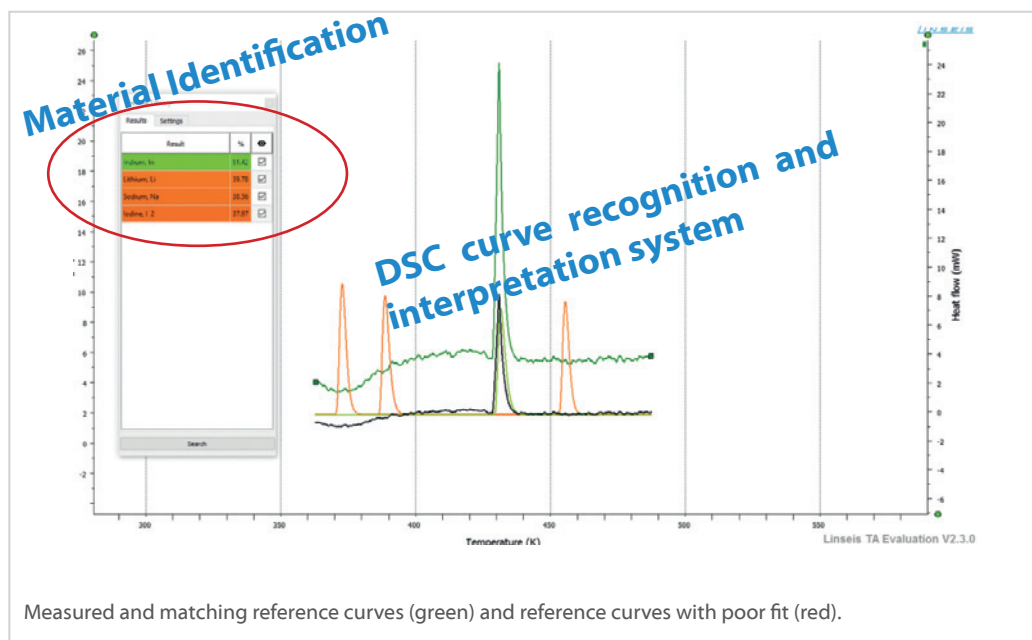

Multi-Instrument

All LINSEIS instruments DSC, DIL, STA, HFM, LFA, etc. can be controlled from one software template.

Report Generator

Convenient template selection to generate customized measurement reports.

Data Base

State of the art data base design enables easy data handling.

Multi-Lingual

Our software is available in many different user exchangeable languages, such as: English, Spanish, French, German, Chinese, Korean, Japanese, etc.

Multi-User

The administrator can generate different user levels providing different rights to operate the instrument. An optional Log file is available, too.

Kinetic software

Kinetic analysis of DSC, DTA, TGA, EGA (TG-MS, TG-FTIR) data for the study of the thermal behavior of raw materials and products.

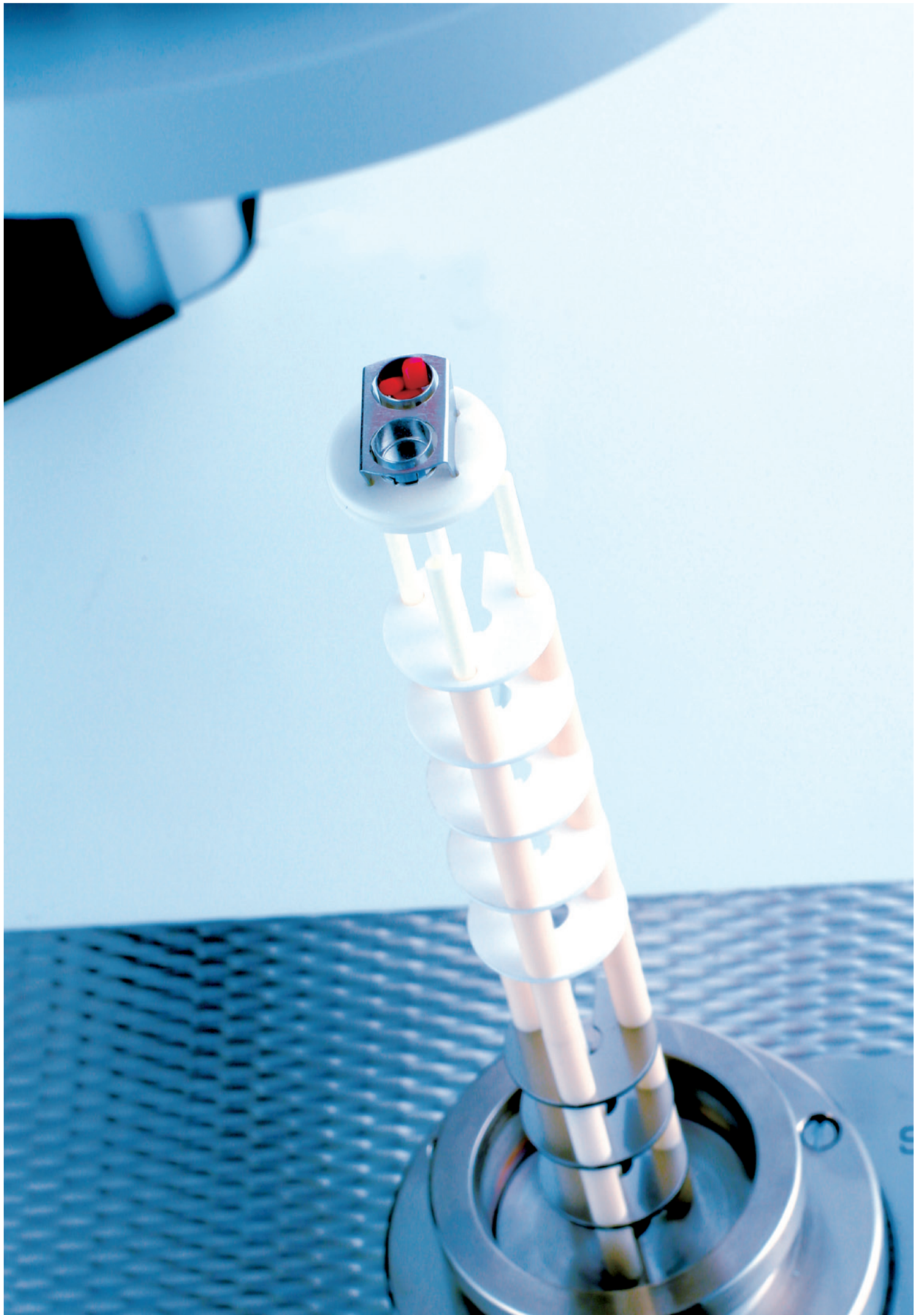

SPECIFICATIONS

		TGA PT 1600		
Temperature range	-150 up to 2400°C			
Vacuum	10 ⁻⁵ mbar (depends on vacuum pump)			
Pressure	up to 5 bar (optional)			
Heating rate	0.01 up to 100°C/min (depends on furnace)			
Temperature precision	0.01°C			
Sample robot	optional 42			
TG				
Resolution	0.025 µg	0.1 µg	0.1 µg	
Sample weight	5 g	25 g	35 / 50 g	
Measuring range	25 / 2500 mg	25 / 2500 mg	35000 mg	
DSC				
DSC-sensors	E / K / S / B / C			
DSC resolution	0.3 / 0.4 / 1 / 1.2 µW			
Calorimetric sensitivity	approx. 4 / 6 / 17.6 / 22.5 µW			
DTA				
DTA-resolution	0.05 µV			
Sensitivity	1.5 µV/mW			
DTA-measuring ranges	250 / 2500 µV			

APPLICATIONS

Decomposition of $\text{CaC}_2\text{O}_4 \cdot \text{H}_2\text{O}$

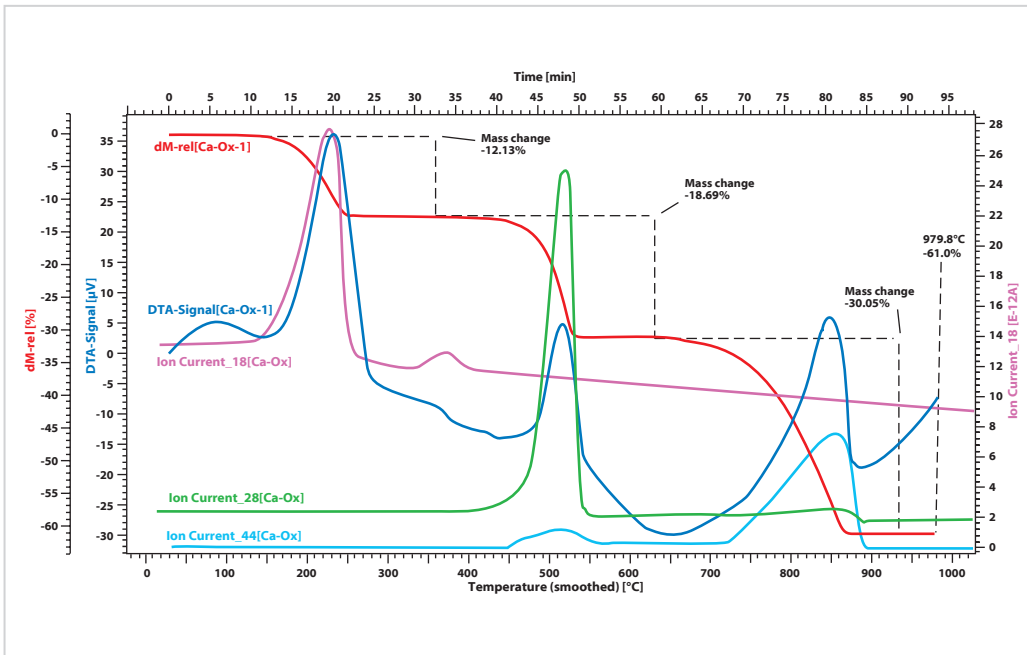

The evolved gases from the decomposition of calcium oxalate has been fed into the mass spectrometer with a heated capillary. The ion currents for mass numbers 18 (water), 28 (carbon monoxide) and 44 (carbon dioxide) have been imported into the graph.

Cement

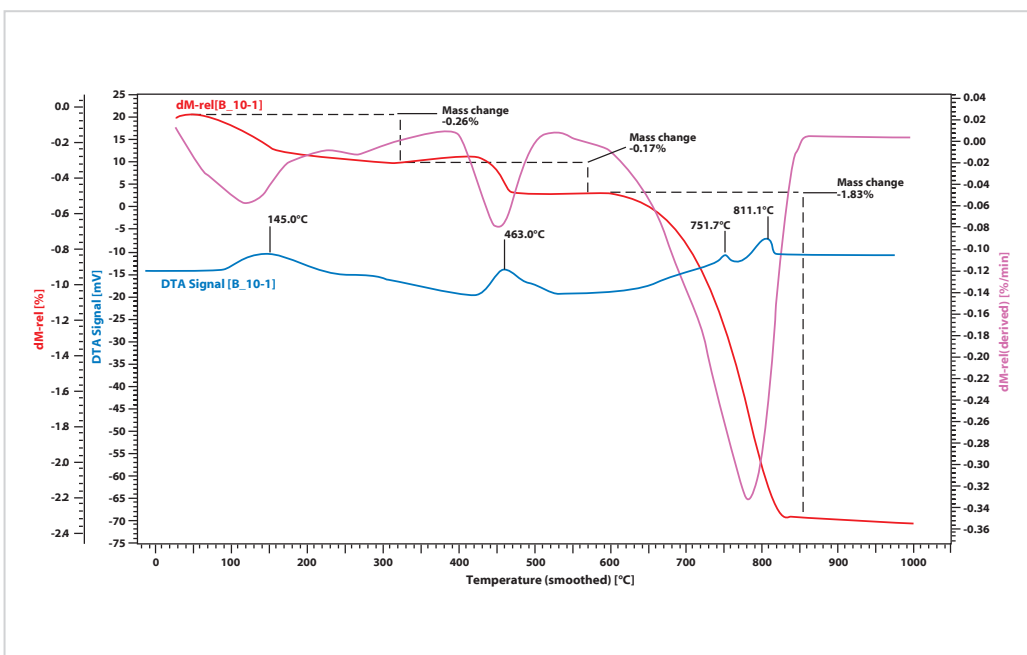

The main parts of cement are tri calcium silicate, di calcium silicate and tri calcium aluminates. Hydrates slowly form after mixing cement with water. The absorbed water evaporates first. Hydrates of the calcium silicate decompose at 570°C. The hydroxides of calcium, magnesium and aluminum follow. Subsequently, CO₂ splits off from calcium carbonate.

Long term baseline stability

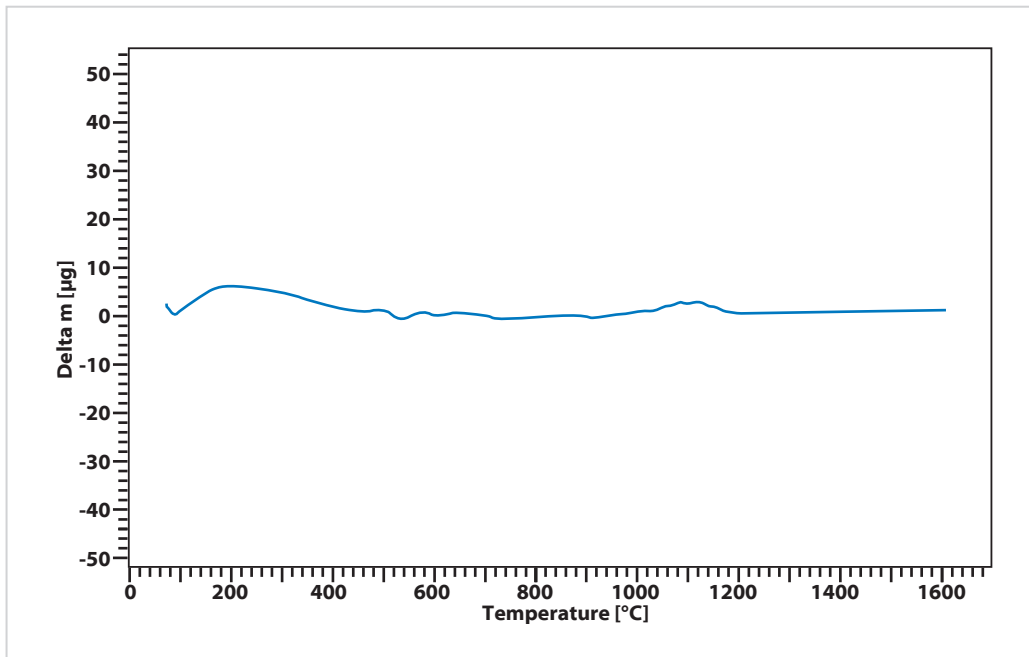

The average baseline stability during linear heating up to 1600°C is within a range of 5µg. This allows highest accuracy and repeatability during the most demanding applications on STA.

Modulated c_p determination

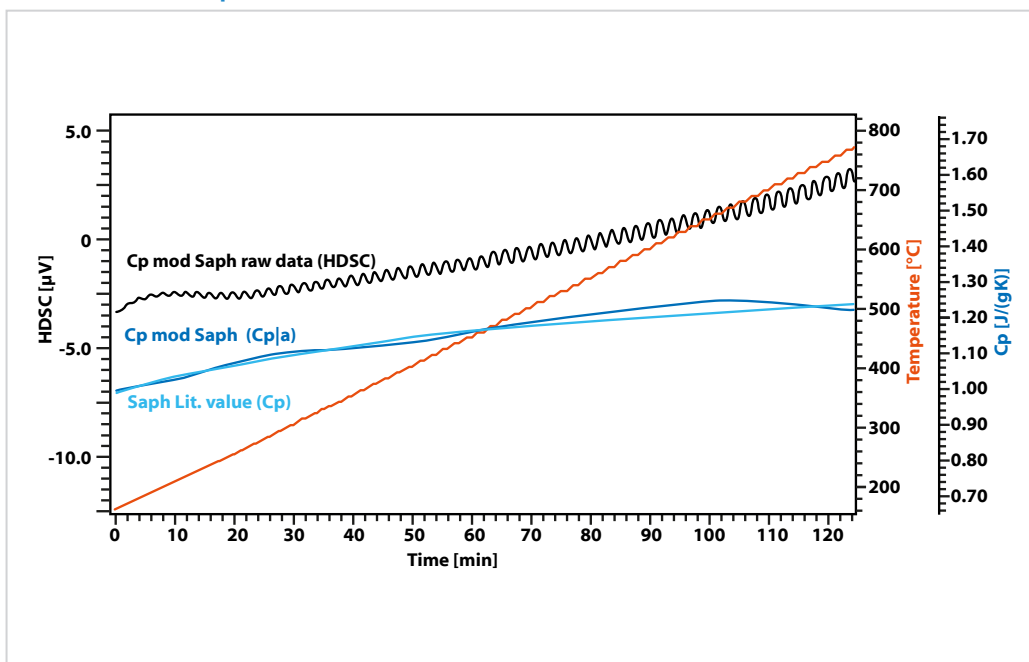

For highest possible accuracy of C_p , the LINSEIS STA and DSC allow the usage of modulated temperature profiles. This technique causes a continuous change in heat flow of the sample and the system can monitor the heat uptake much better than with a linear heating profile. The deviation from the literature value is much smaller than with non-modulated DSC profiles.

The modulated heat flow signal (black) leads to a significant better C_p data (dark blue) that is only slightly different from literature (bright blue). The orange curve shows the modulated temperature signal.

**LINSEIS GmbH Germany**

Vielitzerstr. 43
95100 Selb
Tel.: (+49) 9287-880 - 0
Fax: (+49) 9287-70488
E-mail: info@linseis.de

**LINSEIS Inc. USA**

109 North Gold Drive
Robbinsville, NJ 08691
Tel.: (+1) 609 223 2070
Fax: (+1) 609 223 2074
E-mail: info@linseis.com

**LINSEIS China**

Kaige Scientific Park 2653 Hunan Road
201315 Shanghai
Tel.: (+21) 5055 0642
Fax.: (+21) 6806 3576

**LINSEIS France**

Bureaux Paris
52 Boulevard Sébastopol
75003 Paris
Tel.: (+33) 1 73.02.82.72

**LINSEIS Poland**

Dabrowskiego 1
05-800 Pruszków
Tel.: (+48) 692-773-795

www.linseis.com

Products: DIL, TG, STA, DSC, HDSC, DTA, TMA, MS/FTIR, In-Situ EGA, Laser Flash, Seebeck Effect, Thin Film Analyzer, Hall-Effect

Services: Service Lab, Calibration Service

10/17

LINSEIS